



DLATGS DETECTORS



# DLATGS

## DLATGS DETECTORS

We are a leading manufacturer of DLATGS detectors for Infrared (IR) spectrometers. This position has been achieved by supplying high performance detectors at competitive prices to major IR spectrometer manufacturers all over the world.

The crystal growth process for DLATGS (deuterated L-alanine doped triglycene sulphate) detectors was developed by the company, and unrivalled production skills have enabled the business to continue to expand.

DLATGS detectors are pyroelectric and can be operated uncooled or with temperature stabilisation.

They are supplied in a range of element sizes with options of hermetic sealing, parylene coating, filter material, pin configuration and performance characteristics.

We are the leading supplier of high performance DLATGS detectors for use in FT-IR instruments.

All of the standard build pyroelectric detectors are EU RoHS compliant.

The company is approved by LRQA to ISO 9001:2008 and ISO 14001:2004 Quality Management System standards.

## TECHNICAL SPECIFICATION

ELECTRICAL	
Recommended supply voltage	+8 to 10V
Maximum supply voltage	+25V
Typical output impedance	3.5kΩ
Recommended source load resistor	47kΩ
Integral JFET Pre-amplified	
with gate resistance of 10 or 30GΩ	99,104,105 series
with gate resistance of 100GΩ	106 series
ENVIRONMENTAL	
Operating temperature	-20°C to 55°C
Storage temperature	-20°C to 70°C
Storage humidity	<50% RH
Operating frequency range	10Hz to >20KHz

### Standard Detector - T05 Package

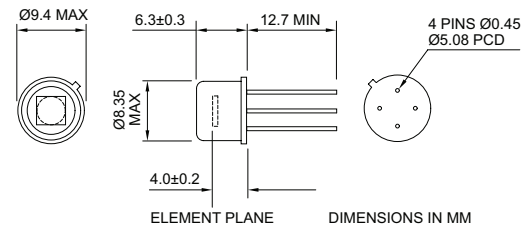

### Temperature Stabilised - T037 Package

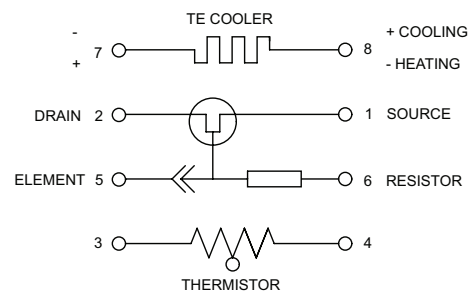
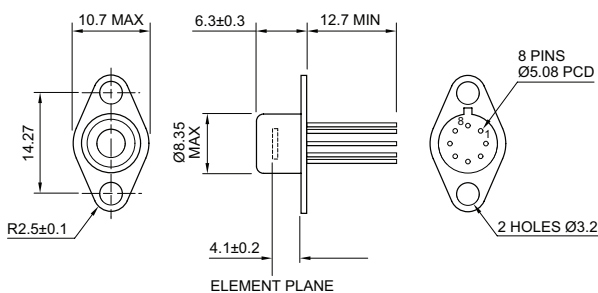

### Temperature Stabilised - T066 Package

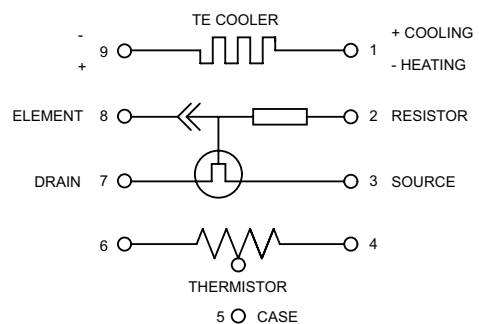
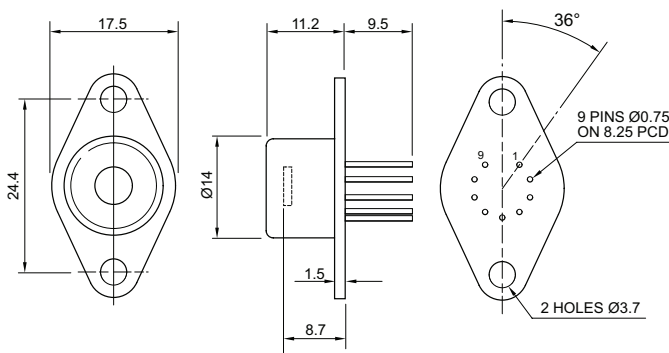

## KEY FEATURES

- DLATGS is one of the highest performing commercial pyroelectric materials available today
- Doped with Deuterium to raise Curie temperature to ~ 59°C
- Doped with L-alanine to prevent permanent depoling after excursions above Curie temperature
- Broad spectral response
- Standard detector supplied in a TO5 package
- Temperature stabilisation available in TO37 and TO66 type packages
- Variety of pinning configurations
- Range of thermal time constants from 4ms to 140ms
- Range of element sizes from 0.25mm to >4mm, round, square and rectangular
- Choice of windows
- Custom designs considered
- Hermetic sealing of window, or Parylene coating for improved environmental durability.



## PERFORMANCE

Typical Performance Data for 2mm diameter element, excluding window:

Detector Series	Performance Category	Thermal Time Constant	10 Hz		100 Hz		1000 Hz	
			Responsivity V/W	D* 10E8cm <sup>2</sup> /Hz/W	Responsivity V/W	D* 10E8cm <sup>2</sup> /Hz/W	Responsivity V/W	D* 10E8cm <sup>2</sup> /Hz/W
99	High Energy	18 ms	2440	6.6	300	6.6	30	3.5
104	Very High Energy	4 ms	-	-	230	3.3	30	2.3
105	High Performance	65 ms	2060	12.6	255	5.5	25	2.5
106	High Performance	140 ms	2150	18	215	9.8	21.5	2.6

### NOTE:

- All measurements refer to unity gain at the detector
- Test data obtained using a Black Body test
- Noise related measurements correspond with unit bandwidth
- Measurements taken at 22°C

### Typical Relative Responsivity, D\* and NEP for Detector Series 99

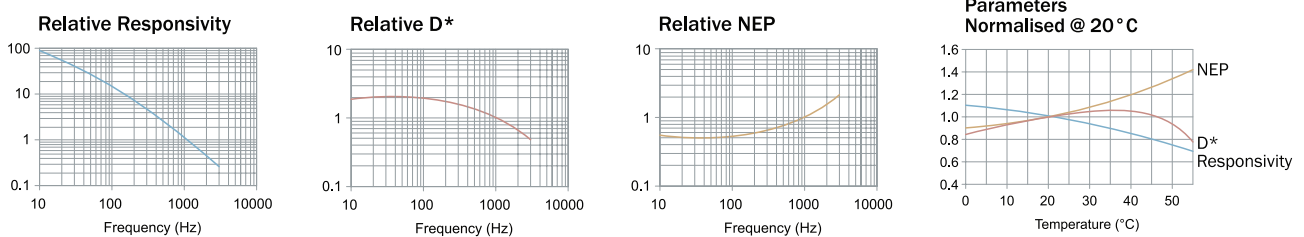

## WINDOWS

Available windows include: CsI, KBr, KRS-5, CaF<sub>2</sub>, BaF<sub>2</sub>, ZnSe, ZnSe-Ar, Diamond, Polyethylene and Sapphire.

Other materials or lenses may be available on request. For greater environmental durability, soft materials may be coated with Parylene, and harder materials may be hermetically sealed.

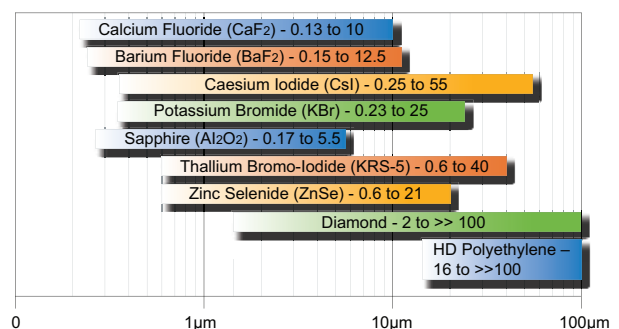



leonardocompany.com

For more information please email [infomarketing@leonardocompany.com](mailto:infomarketing@leonardocompany.com)

Leonardo MW Ltd

First Avenue - Millbrook Industrial Estate - Southampton - Hampshire - SO15 0LG - Tel: +44 (0) 2380 702300

This publication is issued to provide outline information only and is supplied without liability for errors or omissions. No part of it may be reproduced or used unless authorised in writing. We reserve the right to modify or revise all or part of this document without notice.

2017 © Leonardo MW Ltd

LNDE MM08096 1-17

